



Arthur Flury AG | Switzerland

Earthing | Lightning protection | Overvoltage protection

Manual Earthing systems

Edition 2020

Foundation earthing | Circular earthing | Deep earthing

Examples for standardized planning and installation

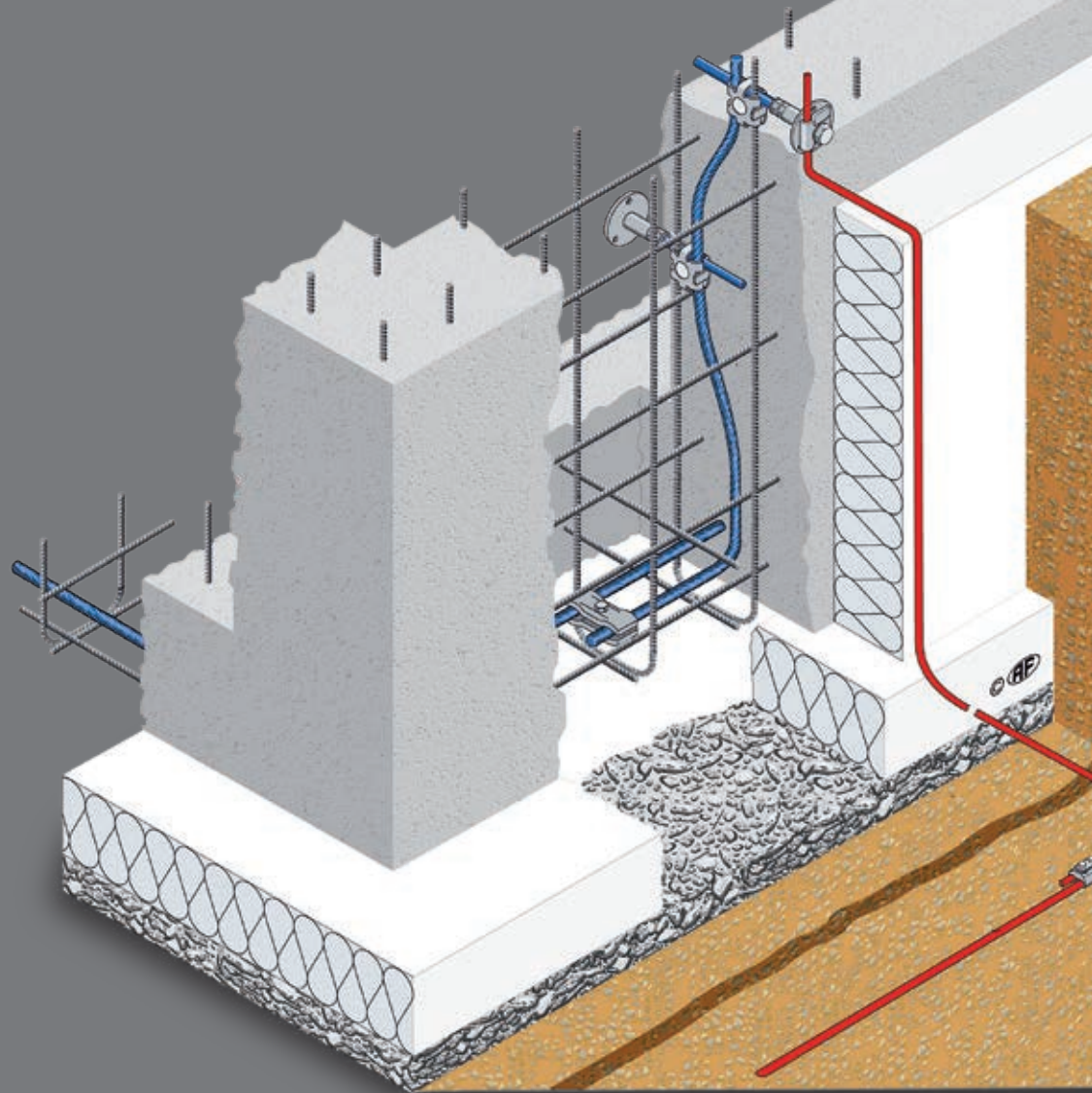

Arthur Flury AG

Fabrikstrasse 4 | CH-4543 Deitingen

Phone: +41 (0)32 613 33 66 | www.aflury.ch

The most important earthing concepts

Earth electrode installed in the concrete

Foundation earth electrode (page 5)

A foundation earth electrode must be installed according to instructions for any new building with electrotechnical installations. It is the best solution from an electrotechnical and a corrosion protection point of view and should therefore be preferably used instead of any other type of earthing.

The earth conductor must form a loop, must be installed along the outer edges of the base plate and enclosed in structural concrete (cement content at least 300 kg/m^3). If reinforcement is provided, it must have an electrically conducting connection to the earth conductor every 5 m.

The foundation earth electrode must be carefully planned and installed.

The connecting leads to the connection points for equipotential bonding and lightning protection must be designed together with the earth conductor loop before construction starts.

The earth resistance should be $\leq 2 \Omega$.

Standards/Rules:

SNR 464113:2015, NIN

	AF-Type	AF-Item number	E number
1	AV 59	240.001.000	156 950 200
2	FE 27	281.076.000	156 940 970

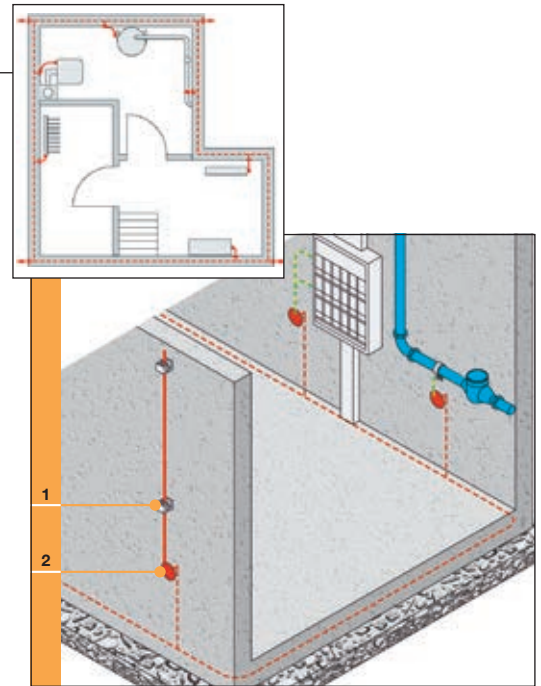

Underground earth electrode

Earth strip (ground loop) (Page 17)

The earth strip (ground loop) is used for buildings with no or insufficient grounding.

The earth conductor must be embedded in wet soil (at least 70 cm deep) and must be connected to form a loop. For conductors and connectors, the same corrosion-resistant material must be used.

All connecting leads to equipotential bonding and to each lightning conductor must be connected directly to the earth conductor loop in a way that is resistant to lightning surge current.

The effectiveness of the earth strip is determined by the soil conditions and the length of the earth conductor.

Aim for an earth resistance of $\leq 10 \Omega$.

Standards/Rules:

SNR 464022:2015, SNG 483755, NIN, Directives of the network operators

	AF-Type	AF-Item number	E number
1	AV 59	240.001.000	156 950 200
2	AL 7	270.025.003	156 831 220
3	AV 6	275.027.114	156 001 090
4	PA 25	266.029.000	156 970 280

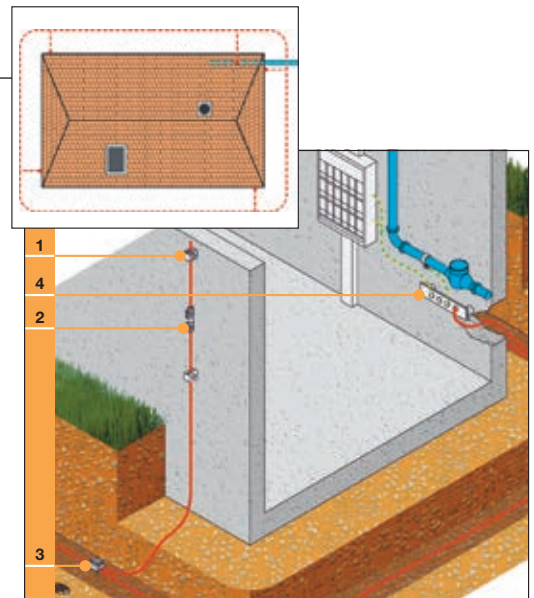

The most important earthing concepts

Underground earth electrode

Deep earth electrode (page 19)

The deep earth electrode is ideally suited as an individual earth electrode or as an addition to systems with insufficient earth resistance.

Deep earth electrodes made of copper are ideal electrically and in terms of corrosion protection. The effectiveness is determined by the soil conditions and the length of the earth conductor.

Aim for an earth resistance of $\leq 10 \Omega$.

Standards/Rules:

SNR 464022:2015, SNG 483755, NIN, Directives of the network operators

	AF-Type	AF-Item number	E number	
1	AV 6	275.027.114	156 001 090	H

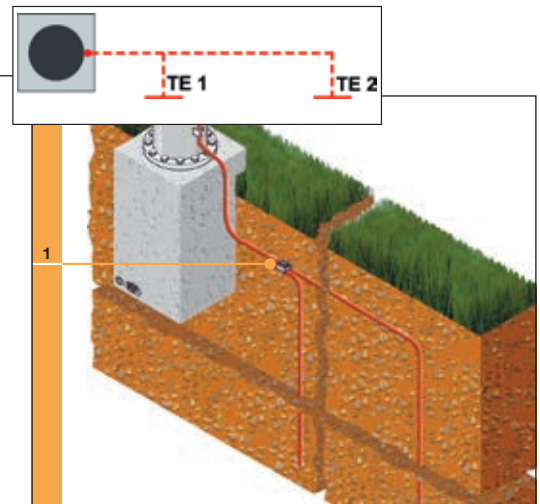

Underground earth electrode

Radial earth electrode

The radial earth electrode can be used as an addition for systems with insufficient earth resistance.

The earth conductor must be embedded in wet soil in its extended state. Its length may not exceed 15 m.

The effectiveness is determined by the soil conditions and the length of the earth conductor.

Standards/Rules:

SNR 464022:2015, SNG 483755 NIN, Directives of the network operators

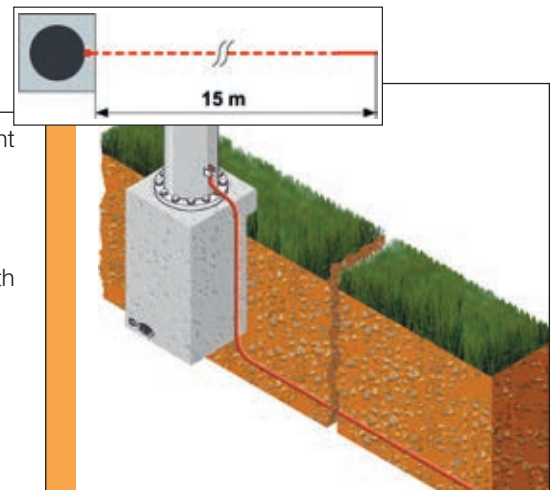

Combined earth electrode

Foundation earth electrodes and underground electrodes are linked

Earthing systems of adjoining buildings must be connected to each other. Measures must be taken to prevent galvanic corrosion.

If a foundation earthing is combined with an underground earth electrode, the underground earth electrode must be made of bare copper.

Different materials should only be combined above ground.

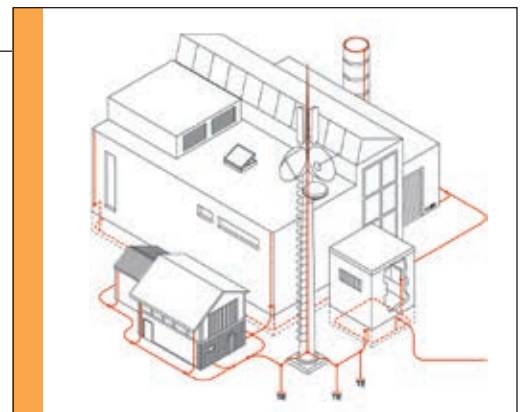

Specification of the earthing system in new construction

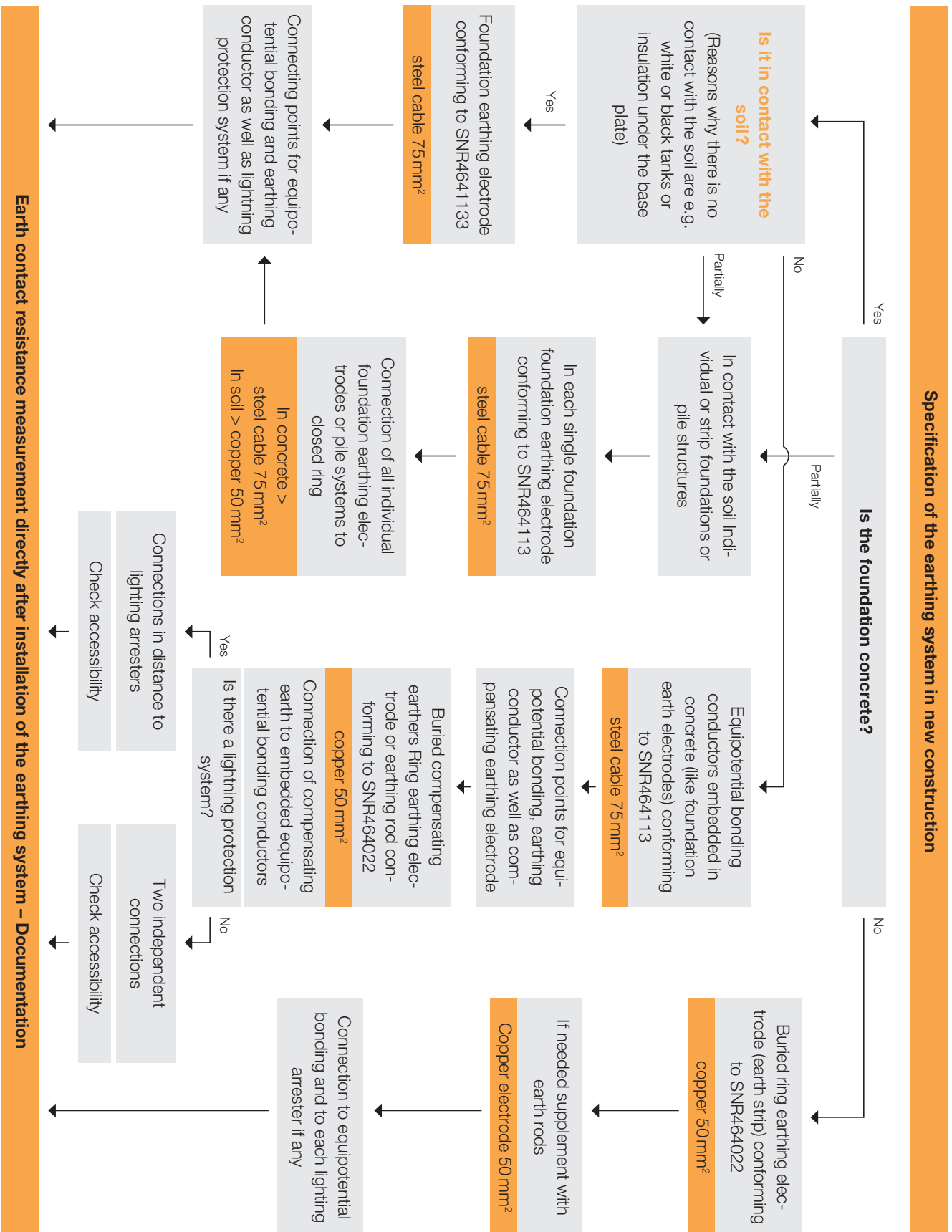

Foundation earthing | Earth conductors and connectors

Foundation earthing essentials

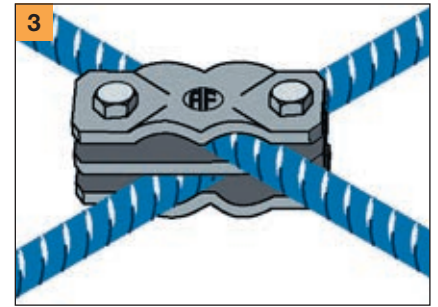
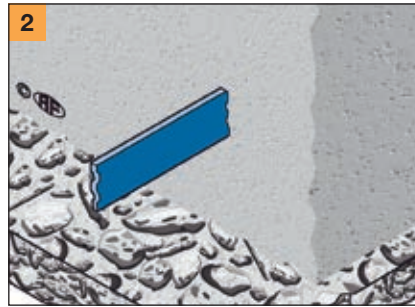
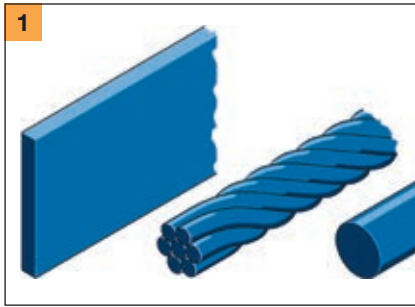

- 1) The earth conductor cross section must be at least 75 mm² steel. Bright or galvanized steel profiles or steel cables are suitable. The earth conductor must be connected to form a loop and installed along the outer edge of the base plate.
- 2) The earth conductor must be enclosed in at least 50 mm of structural concrete. This cover ensures the earth conductor is protected from corrosion.
- 3) Earth conductor connections must duct through short circuit and lightning surge currents. Their design must conform to the standards and be impeccable from an electrotechnical point of view. In addition, the earth conductor must have an electrically conducting connection to the reinforcement every 5 m.

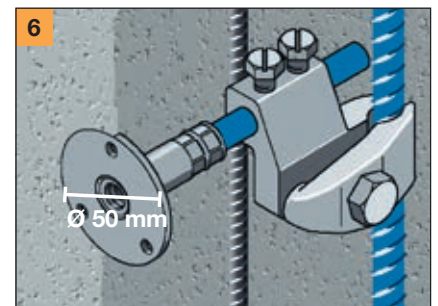
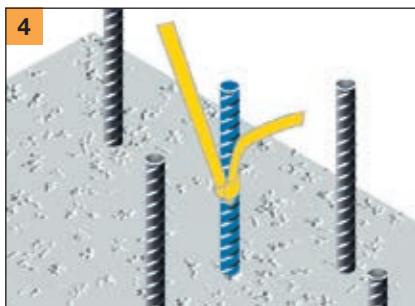

- 4) Possibility of confusion with earth conductor made of reinforced steel. Make sure you mark the conductor prior to concrete casting.
- 5) Bright and galvanized steel may not be guided outside the concrete. Corrosion will destroy the conductor.
- 6) Connection points must be made of corrosion-resistant material (stainless steel/Inox A4 or copper). The change of material in the concrete is possible without problems. After stripping, only the contact washer made of stainless steel A4 is visible. 50 mm in diameter, M10 thread.

Foundation earthing | Earth conductors and connectors

Earth conductor

Steel cable in concrete

Very simple and quick installation. Low logistics expenses. Earth conductor is easily recognisable. Ensure the earth conductor is connected to the reinforcement every 5 m by a clamp (2–4) and that the connection can withstand short circuit currents.

- The **FE 82 foundation earthing set** includes 50 m of 75 mm² galvanized steel cable (1), 10 x FE 41 clamp (2) and 1 x FE 65 connection kit.
- The **FE 83 connection set** includes 1 x FE 69 connection kit, 1 x 3 m 75 mm² galvanized steel cable (1) and 1 x FE 41 clamp (2).

Ideal material: 75 mm² galvanized steel cable (the individual wire Ø must at least be 1.7 mm)

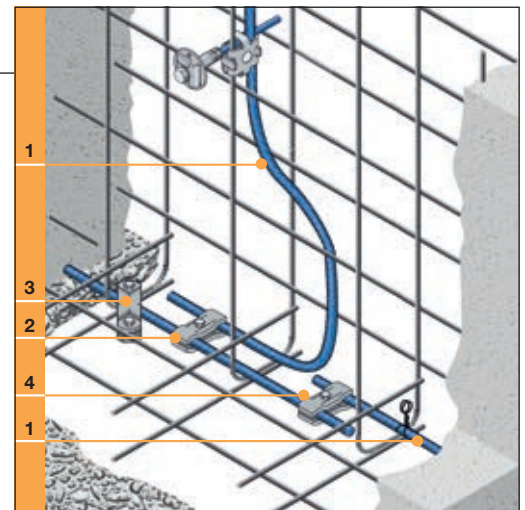

AF Tipo	AF N. art.	E number
FE 82	261.031.000	156 942 010
FE 83	261.032.451	156 941 020
1 Steel cable 75 mm ²	261.031.020	156 990 640
2 FE 41	281.085.000	156 940 130
3 FE 44	281.097.000	156 940 150
4 FE 45	261.068.000	156 830 280

Earth conductor

Reinforced steel in concrete

Suitable for large, industrial buildings. Easy installation using appropriate tools. Cost-effective earth conductor profile.

A terminal (2–5) must be used to establish a connection to the reinforcement which withstands short circuit currents every 5 m.

Caution: Earth conductors made of reinforced steel are no longer recognisable after concrete pouring! This is why they have to be marked beforehand.

Ideal material: Bright reinforced steel or round steel Ø 10 mm.

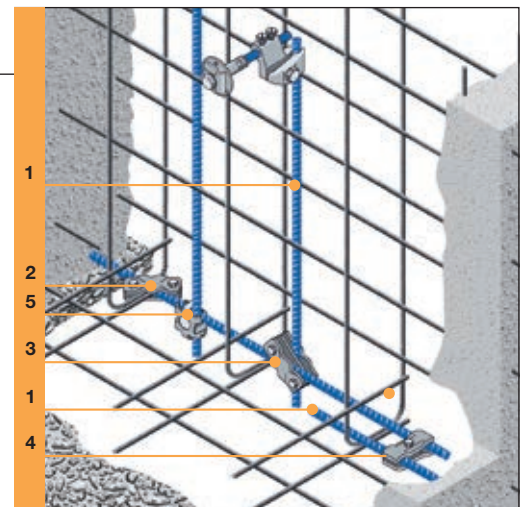
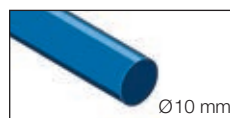

AF -Type	AF -Item number	E number
1 Reinforced steel Ø 10 mm		
2 FE 43	281.095.000	156 940 110
3 FE 44	281.097.000	156 940 150
4 FE 41	281.085.000	156 940 130
5 FE 45	261.068.000	156 830 280

Foundation earthing | Earth conductors and connectors

Earth conductor

Ribbon cable in reinforced concrete

Very suitable for large industrial buildings. Easy to install. Earth conductor is perfectly recognisable. A clamp (2-4) must be used to establish a connection to the reinforcement at least every 5 m which withstands short circuit currents.

Caution: The ribbon cable must always be installed vertically to ensure it is enclosed by the inflowing concrete and no air locks can form.

Ideal material: Bright or galvanized steel strip 25 x 3 mm or 30 x 3 mm

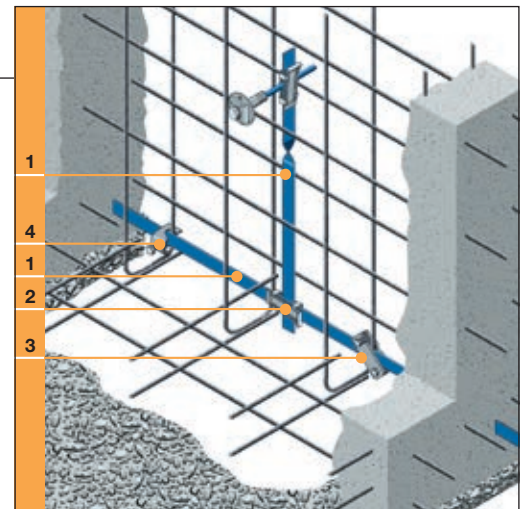

	AF Tipo	AF N. art.	E number
1	Steel strip 25 x 3 mm	261.028.000	100 766 325
2	FE 60	281.082.403	156 940 100
3	FE 43	281.095.000	156 940 110
4	FE 42	281.086.548	156 940 120

Ribbon cable in concrete without reinforcement

Earthing strip supports (3) for stable vertical positioning prior to concrete pouring.

Strip at least 90 mm² (30 x 3 mm)

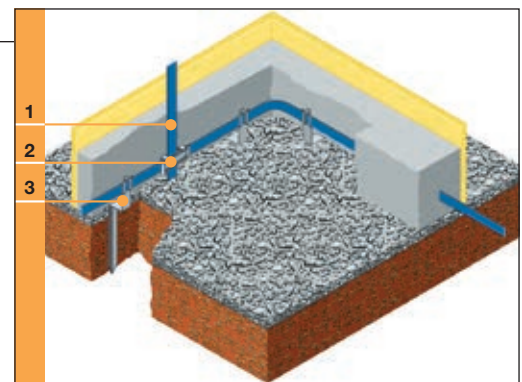
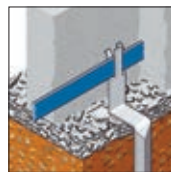

	AF Type	AF N. art.	E number
1	Steel strip 30 x 3 mm	261.021.410	100 766 330
2	FE 60	281.082.403	156 940 100
3	FE 16	281.081.403	156 940 000

Dilatation bridging cast in concrete

The earth conductors of individual concrete segments must be continuously connected. Cast-in dilatation bridging (1) must be corrosion-resistant and must be able to compensate for predictable shifts of concrete segments without being damaged.

Alternative: Visible dilatation bridging

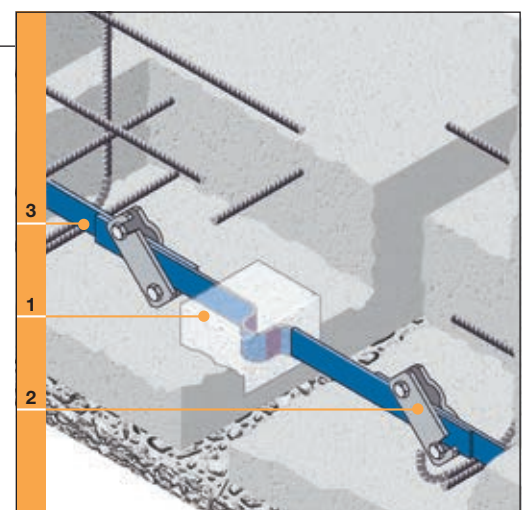
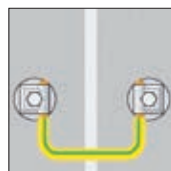

	AF Tipo	AF N. art.	E number
1	FE 33	281.083.403	156 940 300
2	FE 43	281.095.000	156 940 110
3	Steel strip 25 x 3 mm	261.028.000	100 766 325

Foundation earthing | Connection point

Elements of a connection point

Connection points are the central element for the permanent connection to the foundation earthing.

They must be corrosion-resistant and withstand short circuit currents without being damaged. At the concrete surface, the construction chemical, corrosive influence on metals is extremely strong. In addition, there is galvanic corrosion due to the combination of different metals. All our connection points are SEV tested for short circuit currents of 6000 A / 1s and therefore bear safety marks.

1

Connecting part: contact washer and hub made of stainless steel/Inox A4 with M10 internal thread, rod made of construction steel \varnothing 10 mm (75 mm²). A corrosion-resistant connection to the foundation earthing which ducts through short-circuit currents and lightning surge currents without being damaged.

2

Screw terminal: Connection from rod to earth conductor which is resistant against short-circuit currents and easy and safe to install.

3 4

For the installation, the contact surface and the thread are protected against contamination by a red plastic cover. Special stainless nails connect the connecting part firmly to the formwork. After stripping, the special nails can be removed.

5 6 7

The contact plate and M10 screw made of stainless steel/Inox A2 establish a contact-preserving connection from the equipotential bonding conductor or lightning conductor. Instead of the clamping plate, a cable lug can be used as well.

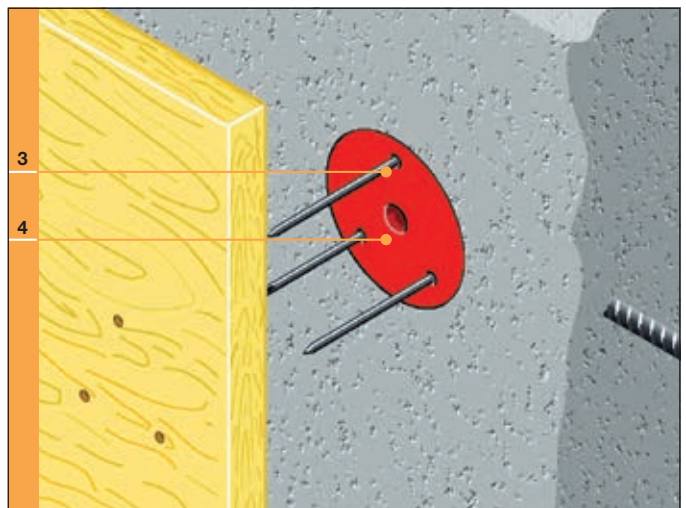
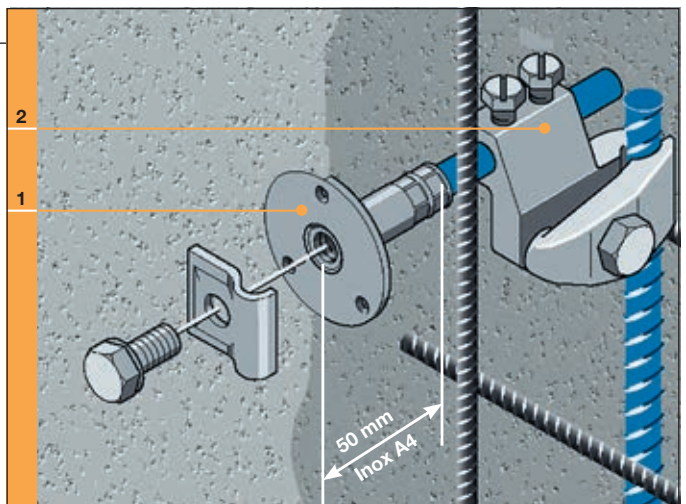

Incorrect «connecting flags»

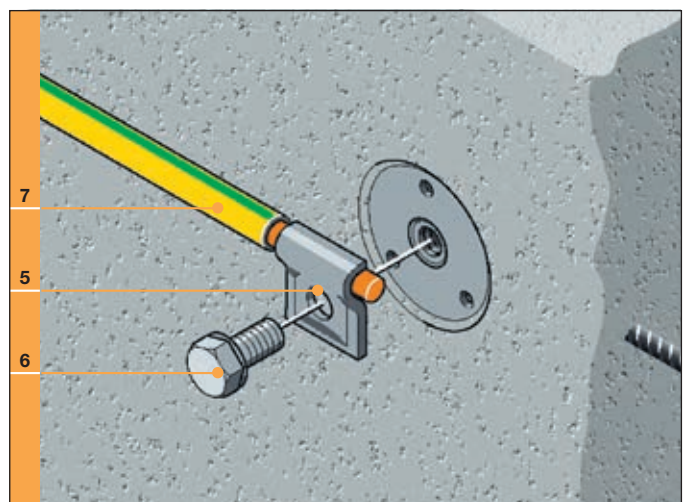
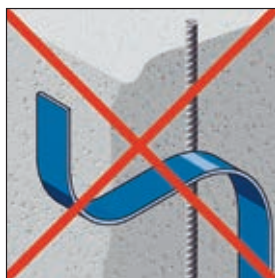

Foundation earthing | Connection point

Flexible connecting sets with 75 mm² steel cable

To be used where maximum flexibility in the vertical conductor routing is required. Connection with round earth conductors with a maximum Ø of 22 mm.

- The **FE 83 connection set** includes parts 1–3: 1x FE 69 connection set, 1 x 3 m galvanized steel cable 75 mm² and 1 x FE41 clamp

AF-Type	AF-Item number	E number
FE 83	261.032.451	156 941 020

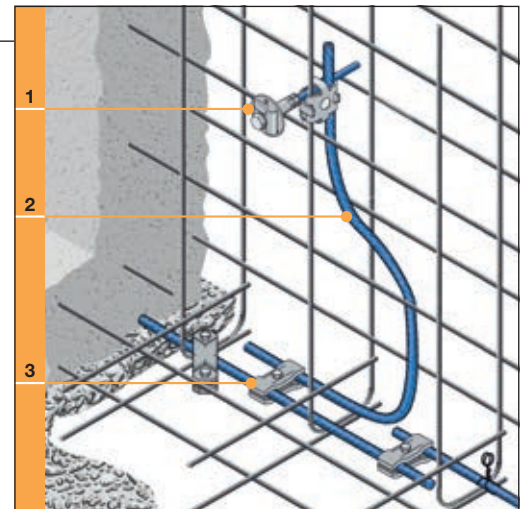

Connection point with round cross clamp

The FE 45 round cross clamp (4) connects the connection point and the flexible conductor (e.g. 75 mm² steel cable) with the reinforcement up to a maximum Ø of 16 mm.

- The **FE 69 connection set** includes parts 1-4 and the FE 45 round cross clamp.

AF-Type	AF-Item number	E number
FE 69	261.050.000	156 940 030

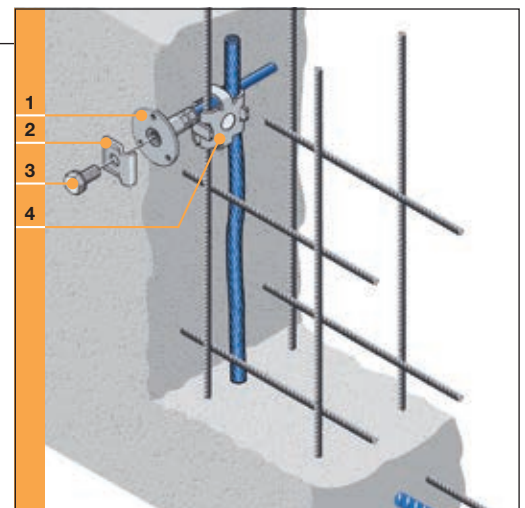

Flexible connection set with 50 mm² Cu cable

Can be used if the formwork and/or the reinforcement require a high level of flexibility (distance compensation).

- The **FE 70 connection set** includes parts 1–4. The 50 mm² CU cable is crimped with the connection point.

AF-Type	AF-Item number	E number
FE 70	260.074.000	156 940 040

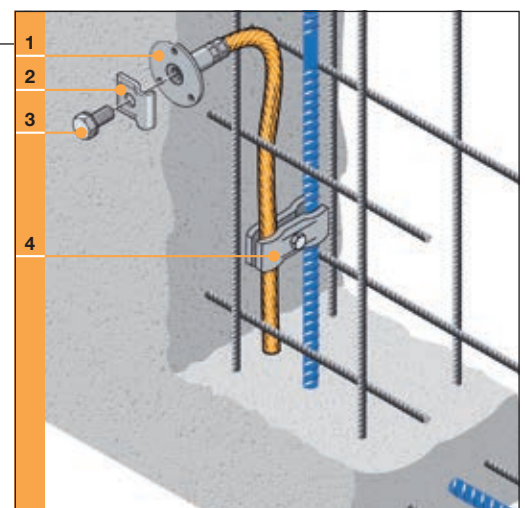

Foundation earthing | Connection point

Flexible connection point with 2-wire connection to earth conductor

Can be used if the connection to the earth conductor is established e.g. using two vertical metal bars of at least 8 mm.

- The **FE 73 connection set** includes parts 1–3. The two 50 mm² steel cables (3) are crimped with the connection point.

	AF-Type	AF-Item number	E number
■	FE 73	280.095.037	156 940 230
■	FE 43	281.095.000	156 940 110

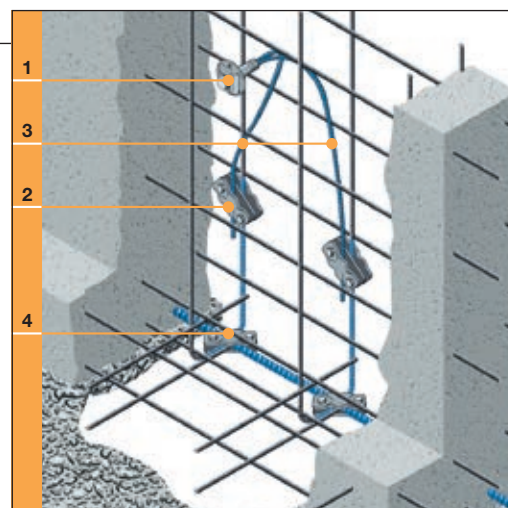

Short connection point for flexible 1-wire connections to the earth conductor

- The **FE 68 connection set** includes parts 1–3. The interconnecting conductor can be a 50 mm² bare copper cable/wire or a 75 mm² steel cable..

	AF-Type	AF-Item number	E number
■	FE 68	280.097.006	156 941 220

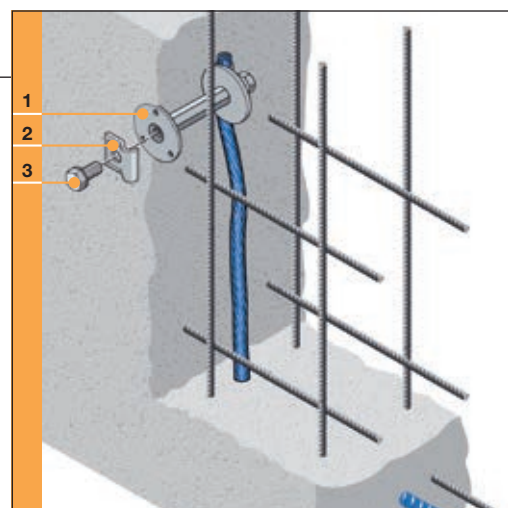

Earth conductor bushing and connection point

- The **FE 26 earth conductor bushing** includes part 1. Available in different lengths, 120, 150, 200, 250, 300 mm, or special lengths on request. Depending on the application, two FE 85 sets (part 2 + 3) clamping plate /screw and a connecting clamp (4), e.g. FE 45, are required.

	AF-Type	AF-Item number	E number
■	FE 26 120 mm	260.035.000	156 940 820
■	FE 26 150 mm	260.037.000	156 940 830
■	FE 26 200 mm	260.034.000	156 940 840
■	FE 26 250 mm	260.043.000	156 940 870
■	FE 26 300 mm	260.044.000	156 940 880
■	2+3 FE 85	285.099.025	156 831 650
■	4 FE 45	261.068.000	156 830 280

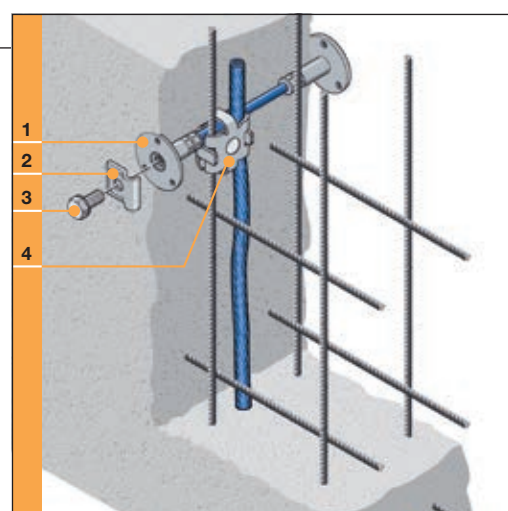

Foundation earthing | Connection point

Connection point with clamp for round steel and cable

Can be used if reinforced steel or round steel \varnothing 10–22 mm or a 75 mm² steel cable is used as an earthing conductor.

■ The **FE 65 connection set** includes parts 1–4.

AF-Type	AF-Item number	E number
FE 65	281.075.037	156 940 200

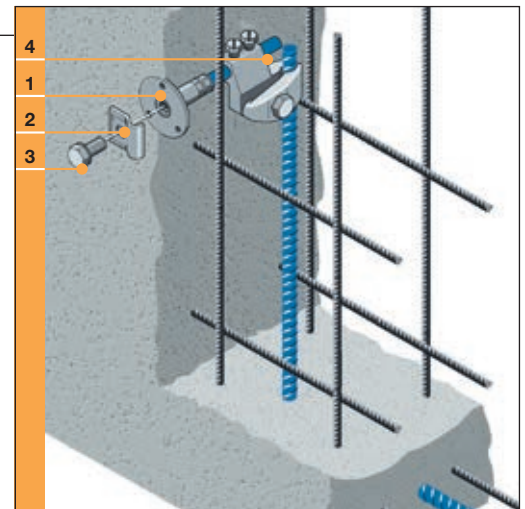

Connection point with cross clamp for reinforced steel (3 pieces)

Can be used if reinforced steel or round steel \varnothing 10–22 mm or 75 mm² steel cable is used as earthing conductor.

AF-Type	AF-Item number	E number
1	FE 27	281.076.000
2+3	FE 85	285.099.025
4	FE 44	281.097.000

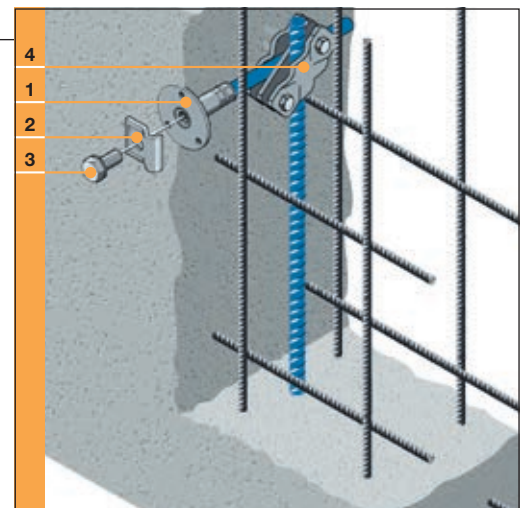

Connection point with wedge type connector

Can be used with ribbon earth conductors size 25 x 3 mm or 30 x 3 mm.

■ The **FE 66 connection set** includes parts 1–4.

AF-Type	AF-Item number	E number
FE 66	281.080.564	156 940 210

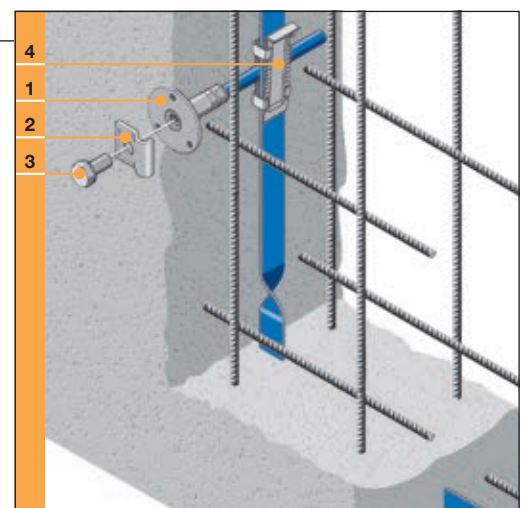

Foundation earthing | Connection point

Connection point with clamp (2 pieces)

Can be used with ribbon earth conductors size 25 x 3 mm or 30 x 3 mm.

	AF-Type	AF-Item number	E number
1	FE 27	281.076.000	156 940 970
2+3	FE 85	285.099.025	156 831 650
4	FE 43	281.095.000	156 940 110

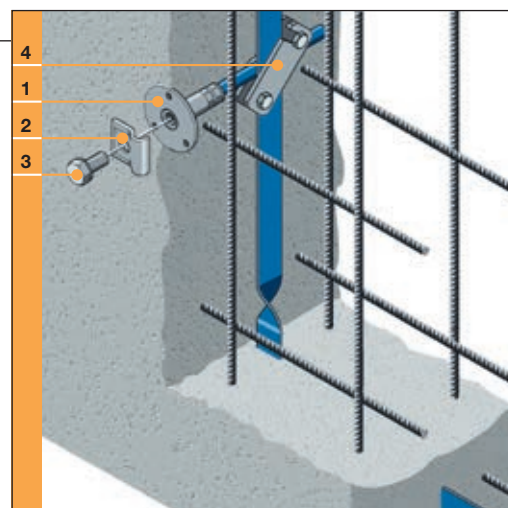

Special types of mounting

Connection point inside element formwork Attachment using mounting bracket without nails

The connection point (1) is connected to the Constri pipe (3) using the mounting bracket (2) and clamped firmly by the clamping bolt (5) of the element formwork. The fixed positioning of the connection point is done without nails.

The **FE 75 connection set** includes parts 1–4.

	AF-Type	AF-Item number	E number
1-4	FE 75	260.029.320	156 940 020

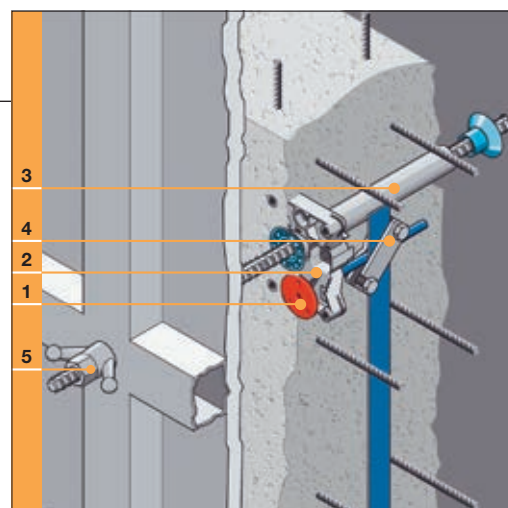

Special types of mounting

Connection point at thin-walled formwork Fixed with mounting bracket and four nails

If the connection point (3) is mounted to thin-walled formwork using a mounting bracket (1), four nails (2) and a large contact face, ensure that the connection point is positioned securely during concrete pouring.

After stripping, the nails can be pulled out and completely removed.

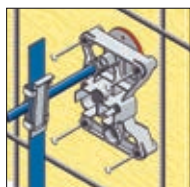

	AF-Type	AF-Item number	E number
1+2	FE 84	260.038.000	156 941 900
3	FE 27	281.076.000	156 940 970
4	FE 60	281.082.403	156 940 100

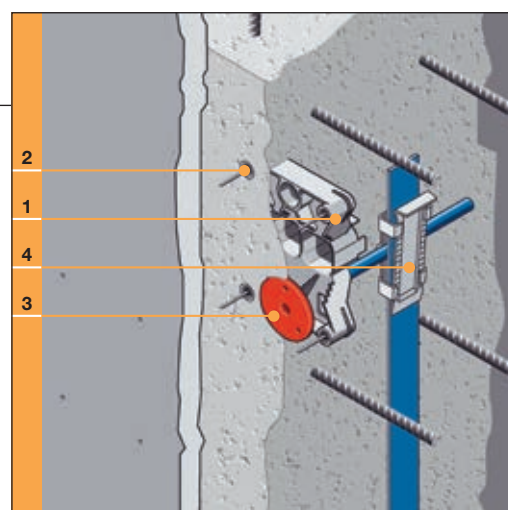

Foundation earthing | Connection point

Special types of mounting

Connection point without fixed connection to the formwork

Tightly screw the FE 30 screw clamp (2) to the reinforcement (min. \varnothing 8 mm). Adjust the red plastic cover of the contact plate of the connection piece (1) to the future wall surface +1 cm and fix the rod in place (the 1 cm protrusion will create the required contact pressure to the formwork).

Establish a good contact between the earth conductor and rod of the connection piece with wedge type connector (3).

	AF-Type	AF-Item number	E number
1	FE 27	281.076.000	156 940 970
2	FE 30	281.077.037	156 940 170
3	FE 60	281.082.403	156 940 100

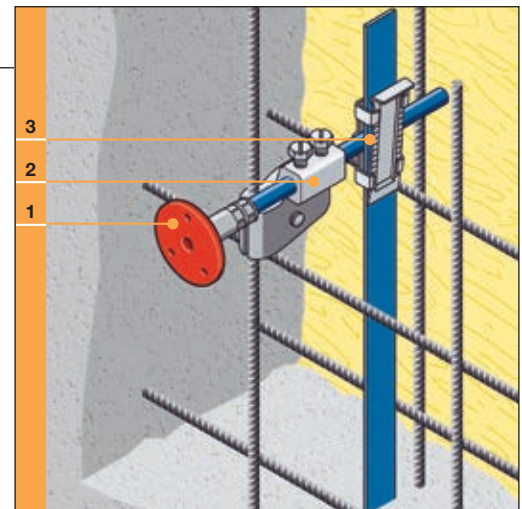

Special types of mounting

Connection set positioned on top

To position a set on top, we recommend using our FE76 «vertical set». The vertical installation structure (4) is mounted to the bottom reinforcement. After that, the set (1) can be adjusted to the upper edge of the concrete, accurate to the millimetre. Optionally, the FE cable can be inserted into the round cross clamp (2).

- The **FE76 vertical connection set** includes parts 1-4.

	AF-Type	AF-Item number	E number
1	FE 76	260.077.000	156 940 080
2	FE 45	261.068.000	156 830 280
3	FE 41	281.085.000	156 940 130
4	Vertical installation structure		

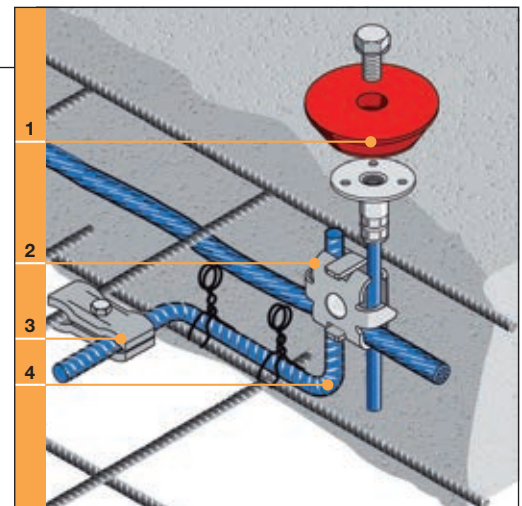

Connection point subsequently installed in existing building

Connection points can be subsequently installed in existing buildings if a continuous steel reinforcement of at least \varnothing 8 mm is provided. At least two metal bars \varnothing 8 mm leading vertically to the base plate must be connected to the connection point. Sufficient earth resistance must be verified by measurements.

The opening must be professionally closed to ensure damage due to corrosion is prevented.

- The **FE 86 connection set** includes parts 1-3.

	AF-Type	AF-Item number	E number
1	FE 86	281.104.000	156 941 200

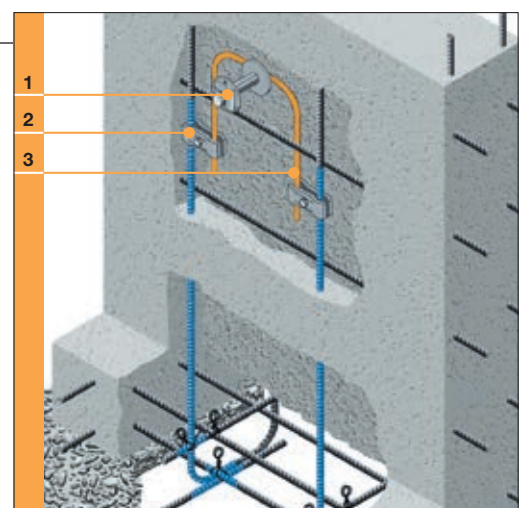

Foundation earthing | Connection point

Connection point extension for insulated facades

Using a special stainless steel extension (1), the connection point can be adjusted precisely to the new wall surface (plaster) for facades with heat insulation. The extended connection point only requires a minimum aperture in the insulation.

	AF-Type	AF-Item number	E number	
1	FE 31	281.089.302	156 940 290	H

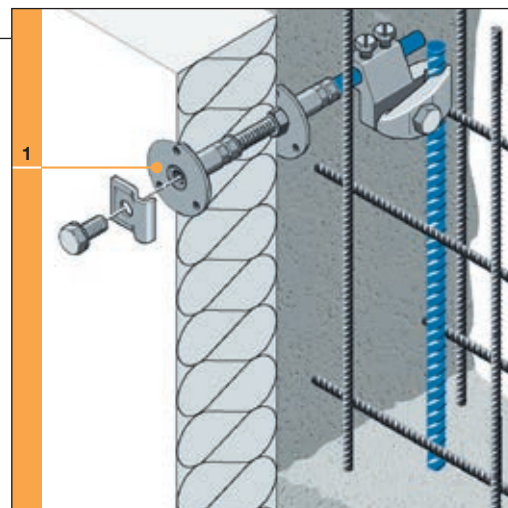

Gasket to connection set for buildings with grouted sealing

The gasket for connection fittings FE 35 can be used with potted seals a tight connection point in accordance with SIA 271 / 272. Fits all connection fittings with M10 thread.

	AF-Type	AF-Item number	E number	
1	FE 35	260.078.022	156 941 290	H

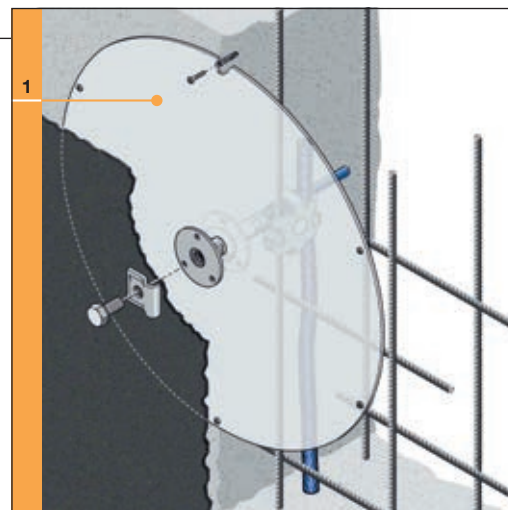

Connecting lug for Strip

For the professional connection of grounding tape on the connection set. The FE 88 connection lug fits all fittings with M10 thread. Two sizes are available for tapes up to 30 mm or up to 50 mm Width.

	AF-Type	AF-Item number	E number
1	FE 88 30 mm	260.071.004	156 809 040
1	FE 88 50 mm	260.071.005	156 809 050

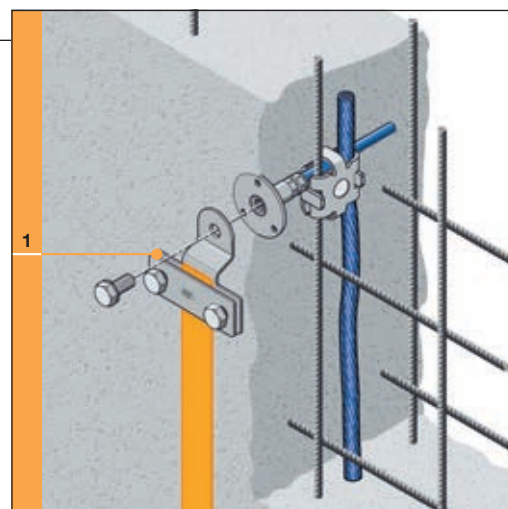

Foundation grounding | Insulated foundation grounding

Heat-insulated foundations – e.g. Minergie buildings

Insulated foundations have no contact to the soil. An additional earth electrode in the soil is added.

As an additional earth electrode in the soil, ground loops or several copper earth rods can be used.

Additional earth electrode, ring version:

The ground loop must be installed in wet soil.

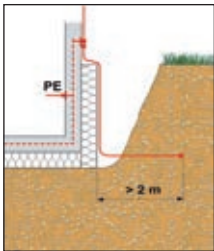

Additional earth electrode, rod version:

Each earth rod must be driven down to a length of at least 2.5 metres.

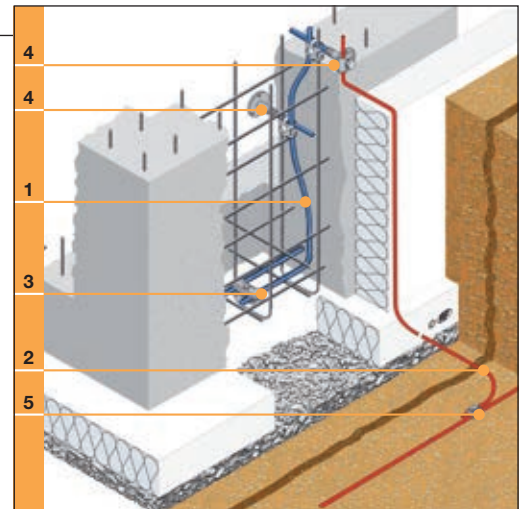
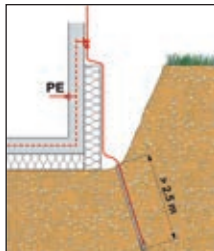

The following applies to both additional earth electrode versions:

The «foundation grounding» serves as equipotential bonding conductor embedded in concrete in these configurations.

For buildings with mandatory lightning protection, the lightning rods must be connected to the earth strip (ground loop) or earth rods so that they are resistant to lightning surge currents.

For other buildings, at least two independent connections from the «foundation grounding» to the underground earth electrode must be established according to SNR 464113:2015.

To make the subsequent connection of lightning rods a lot easier, we recommend installing these connections every 15 metres or even at every building edge.

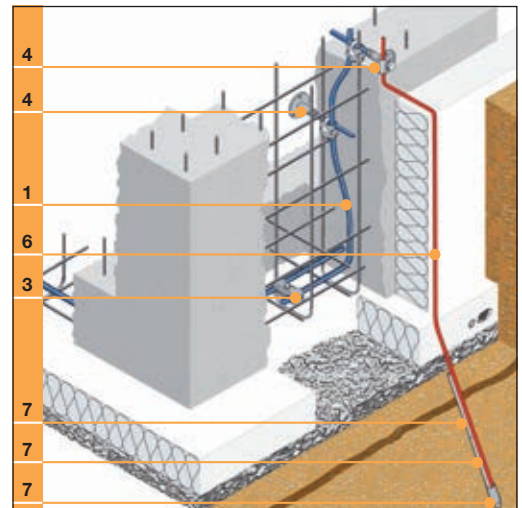

	AF Tipo	AF N. art.	E number
1	Steel cable 75 mm ²	261.031.020	156 990 640
2	Cu wire 8 mm	265.021.027	100 032 180
3	FE 41	281.085.000	156 940 130
4	FE 69	261.050.000	156 940 030
5	AV 6	275.027.114	156 001 090 H
6	Cu cable 50 mm ² spec.	265.017.552	156 990 620
7	TE 1	261.002.020	156 980 100
7	TE 2	261.003.513	156 980 000
7	TE 3 (min. 2 pcs.)	261.004.021	156 980 010

Foundation grounding | Insulated foundation grounding

Foundations insulated against water pressure – e.g. yellow or black tub

If the foundation on the outside is specially sealed against the penetration of water and thus insulated against the ground, a replacement earth electrode must be installed outside of this seal. (Same as for the thermally insulated buildings)

Then the ring earth or deep earth variant is again available.

The connection points for the replacement earth electrode should be arranged as easily accessible as possible.

Waterproof connection set

If waterproof concrete is used, waterproof connection sets must be used.

The FE 24 set fulfils this requirement and is tested for a water pressure of up to 1 bar.

	AF-Type	AF-Item number	E number
1	FE 24	281.076.020	156 941 990
2+3	FE 85	285.099.025	156 831 650
4	FE 45	261.068.000	156 830 280

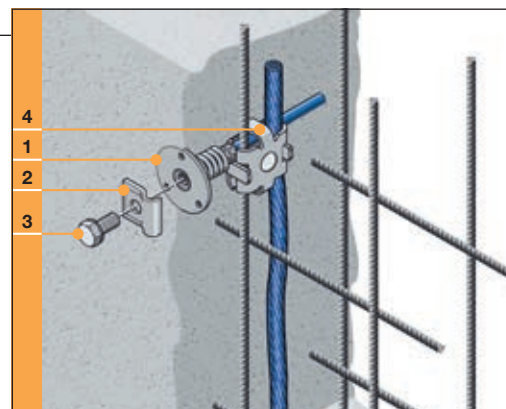

Foundation earthing | Tunnel construction

Earthing in tunnel construction

Arthur Flury AG also significantly contributes to the development of earthing systems for tunnel construction projects and of earthing and equipotential bonding systems for building and lightning protection technology. The leading companies in tunnel construction, tinsmithing and electrical installation have been our customers for years. The earthing and lightning protection system by Arthur Flury AG includes all system components for the comprehensive protection of people, buildings and the electrotechnical infrastructure. The products comply with the state-of-the-art at the highest level. Lightning protection components, for example, are tested for lightning surge currents up to 100 kA (10 / 350; class H) and the foundation earthing material is tested for short-circuit currents.

The catenary material by Arthur Flury AG is used in over 40 countries. Tram, metro and commuter trains of the largest cities in the world as well as regional and national railway companies rely on the quality of our products and services.

Order our railway technology catalogue.

	AF-Type	AF-Item number	E number
1	FE 71 435mm	281.111.005	156 902 080



Connection point for curved parts of tunnels

The FE71 connection set is available in two lengths and includes parts 1 to 3.

	AF-Type	AF-Item number	E number
1-3	FE 71 435mm	281.111.005	156 902 080
	FE 71 1035mm	281.111.000	156 902 180



Circular earthing | Earth conductors and connectors

Essential information on circular earthing

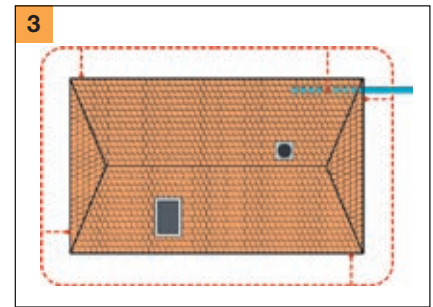
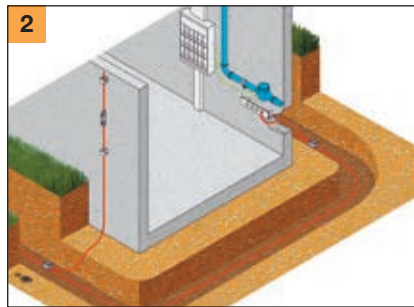
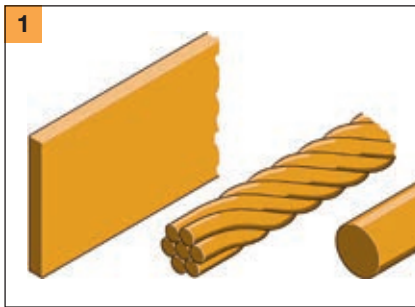

- 1) Cross section of the earth conductors at least 50 mm² bare copper. Strips, cables or loop conductors are suitable.
- 2) The earth conductor must be installed in wet soil. The minimum depth is 70 cm.
- 3) The earth conductor must be installed at a distance of at least 1 m from the building to create a loop.



- Earth conductor connections must duct through short circuit and lightning surge currents and can therefore only be designed with tested, class H connectors (refer to the manual «External lightning protection»).
- For conductors and connectors, the same corrosion-resistant material must be used. Usually bare copper.
- 4) Cross clamp for wire and strip AV 46
 - 5) Branch joint for wire AV 5
 - 6) Floor wire clamp AV 6

Underground round cables

If a round cable is installed, it can be a rope or a round wire.

Ideal material:

50 mm² copper cable
(the minimum individual wire Ø is 1.7 mm)

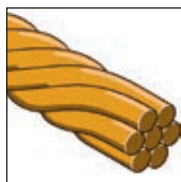

Ideal material:

Copper wire
8 mm

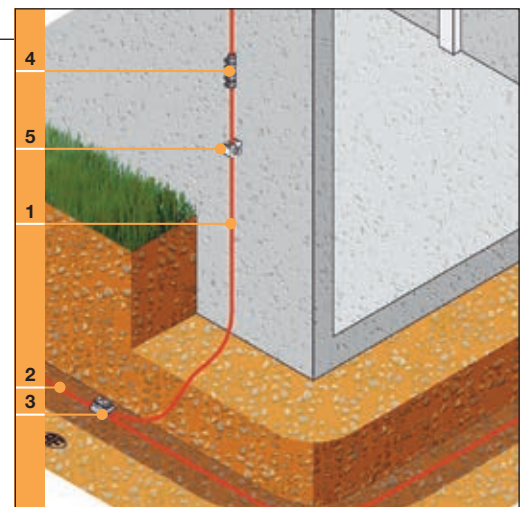
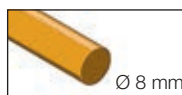

	AF Tipo	AF N. art.	E number
1	Cu wire 8 mm	265.021.027	100 032 180
2	Cu cable 50 mm ²	265.017.552	156 990 620
3	AV 6	275.027.114	156 001 090 H
4	AL 7	275.017.000	156 980 550 H
5	AV 59	240.001.000	156 950 200
	AV 60	240.013.000	156 950 700

Circular earthing | Earth conductors and connectors



Underground copper strip

Al posto dei conduttori di terra rotondi può essere posato anche una bandella.

Ideal material:

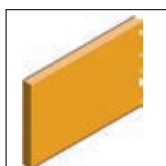
Copper strip 50 mm²
Minimum thickness 2 mm
e.g. 20 x 2.5 mm



	AF Tipo	AF N. art.	E number
1	Cu wire 8 mm	265.021.027	100 032 180
2	Cu strip 20x2.5 mm	215.003.220	100 732 270
3	AV 46	275.045.404	156 831 530 
4	AL 7	275.017.000	156 980 550 
5	AV 59	240.001.000	156 950 200
	AV 60	240.013.000	156 950 700

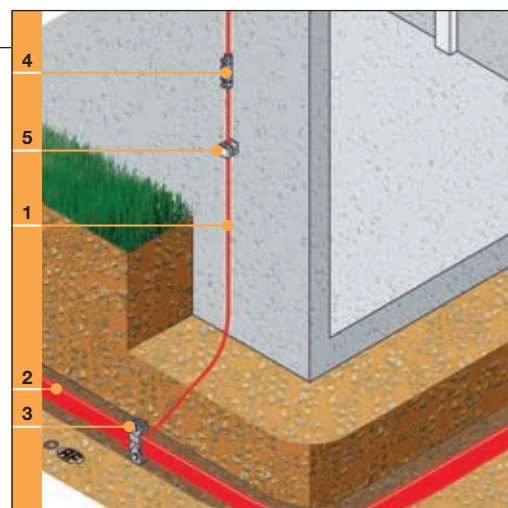

Compensating for poorly installed earth conductors



80% of the length of circular earthing must be installed underground.

If this is not possible, missing lengths exceeding 20% and 20 m must be compensated for. More than 20% or more than 20 m may not be missing under any circumstances.

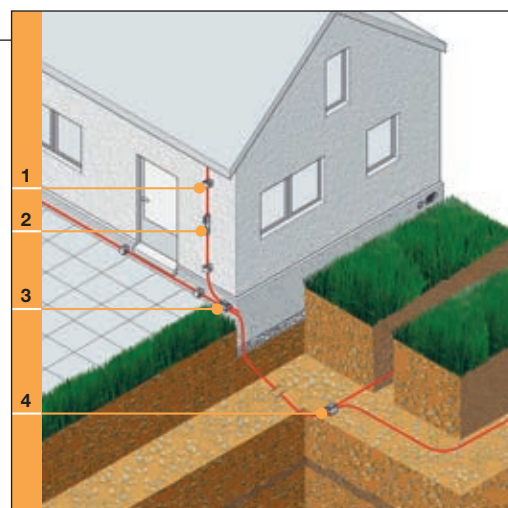
Radial earthing may be used for compensation.



If the compensation is designed with earth rods, the length of the rod used counts twice.

	AF Tipo	AF N. art.	E number
1	AV 59	240.001.000	156 950 200
2	AL 7	270.025.003	156 831 220 
3+4	AV 6	275.027.114	156 001 090 

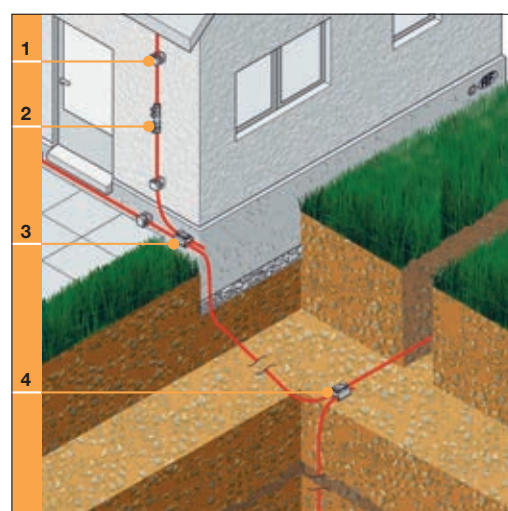

Circular earthing | Earth conductors and connectors

Essential information on deep earthing

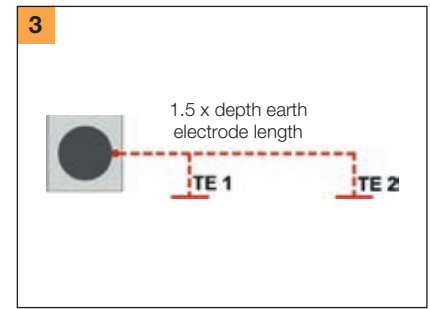
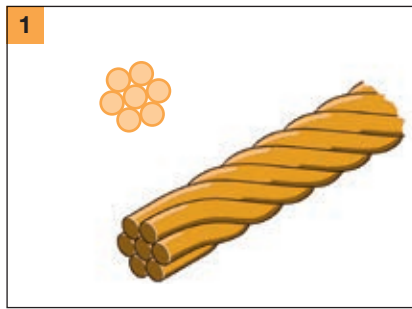

- 1) A 50 mm² bare copper cable will be used as earth electrode. The diameter of the individual wires is 3 mm.
- 2) Earth conductor connections must duct through short-circuit currents and lightning surge currents and can therefore only be designed with tested, class H connectors (refer to the «External lightning protection» manual). The same corrosion-resistant material must be used for conductors and connectors; usually bare copper.
- 3) Deep earth electrodes must reach an effective electrode length of at least 2.5 m. Adjoining earth electrodes must be installed at a distance of 1.5 times the electrode length.

Application of deep earthing systems with copper electrode

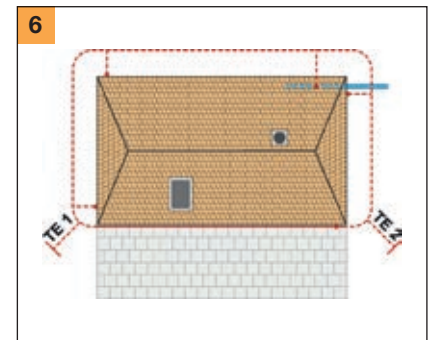
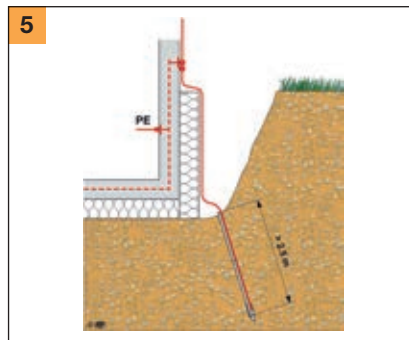
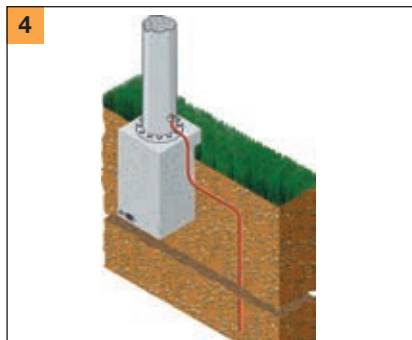

- 4) **As individual earth electrode** for buildings such as masts, antennas, chimneys, towers, transformer stations, electric containers, etc. Require powerful earthing according to the electrotechnical and lightning protection requirements. For earthing systems for lightning protection which are subsequently installed in existing EFH, a deep earth electrode according to SNR 464022:2015 is particularly suitable as well.
- 5) **As additional or replacement earth electrode** for insufficient earth electrodes such as water pipes which are replaced or insulated foundations or corroded earthing systems or small foundations. These can be easily complemented or replaced by deep earth electrodes.
- 6) **As compensation electrode.** The deep earth electrode is ideally suited to compensate for missing ground loops. According to the lightning protection principles SNR 464022:2015, the lengths of the deep earth electrodes count twice for the compensation.

Deep earthing with copper electrode

The system

The principle

The technical and economic benefit of the deep earthing system is the separation of the advancing rods (steel) and the earth electrode (copper). This means that the deep earthing system fulfils any requirement, complies with the standards and can be used for any advancing direction without the risk of breakage.

Benefits of the copper electrode

- Completely corrosion-resistant. This means that the earth resistance is constant throughout the lifetime of the system.
- Optimum electrical conductivity and mechanical strength.
- Uninterrupted electrode up to the connection point
- Suitable for the connection to other earthing systems (e.g. foundation earthing)
- Compliant with standards acc. to SNR 464022:2015

Benefits of the advancing rods

- Selection between two rods: standard (\varnothing 17 mm) and reinforced (\varnothing 21 mm). The decisive factors for the selection are the nature of the soil and the advancing tool
- Rod can also be extended, if required
- Simple and quick advancing possible with all conventional chisel hammers or manually
- Always at optimum working height (10–110 cm above the ground)
- The final extension pipe can be pulled back out and used again
- Steel rods offer protection as a sacrificial anode

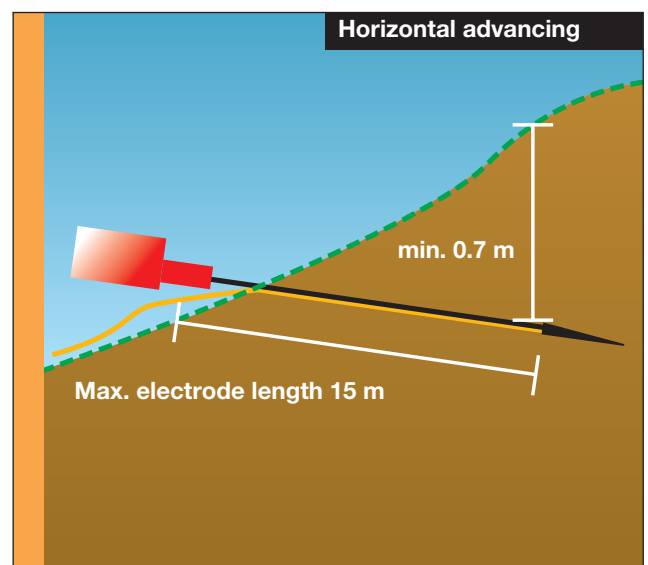
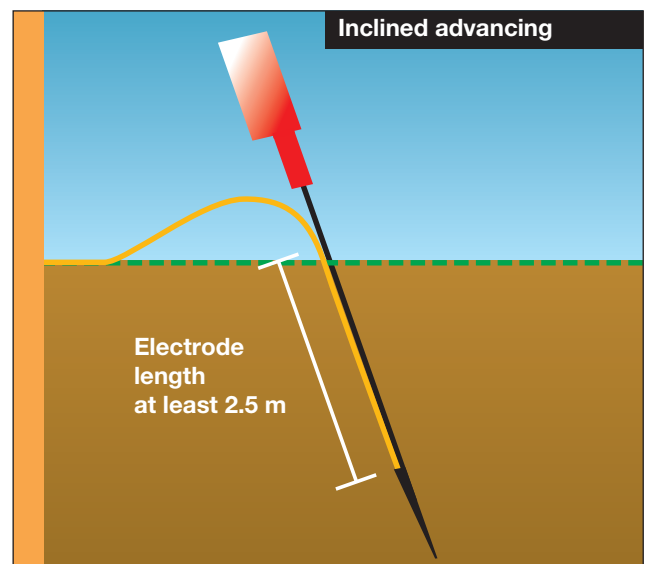
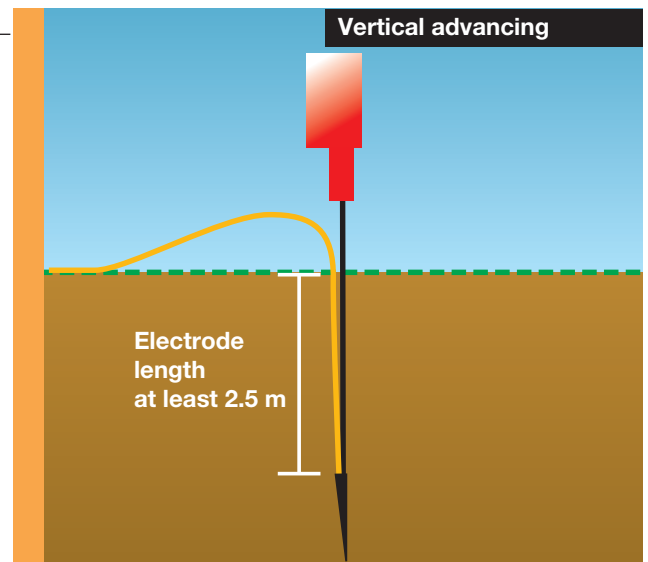

Deep earthing | Procedure

Did you verify reliably that neither the electric cable nor any conduit systems or underground structures are located in the advancing area of the deep earth electrode?

Select the appropriate advancing rod

Soil conditions	Advancing tool	Size of advancing rod
normally grown, heaped up	conventional chisel hammer	Ø 17 mm
hard, rocky	conventional chisel hammer	Ø 17 mm or Ø 21 mm
hard, rocky, compressed	heavy chisel hammer or pile driver	Ø 21 mm

1 First, push the special 50 mm² copper cable (electrode) down to the advancing tip and position it against the protrusion.

2 Then, push the notch of the guide tube against the copper cable into the advancing tip. Use the hammer to drive the guide tube down to the tip and properly wedge the cable in this way.

Position the guide tube with the tip and the copper cable (electrode) at the desired location. Attach the chisel hammer with the correct insert, align it to the guide tube and drive it into the soil.

3 Attach the extension tube and drive in the minimum electrode length of 2.5 m. **Ensure that the copper cable (electrode) is fed and pulled in without obstructions.**



Deep earthing | Procedure

- 4** Measure the earth resistance at the copper cable 4 (electrode). A value ≤ 10 Ohm is desirable. (To do this, the chisel hammer must be removed from the rods!)

Decide whether the same deep earth electrode should be pushed in further or a second deep earth electrode should be installed at the required minimum distance (1.5 x electrode length).

Retract the final extension tube with the removal tool and use it to install the next deep earthing system.

An earthing measurement log should be created for every object. For every deep earth electrode, the electrode length and the earth resistance must be logged.

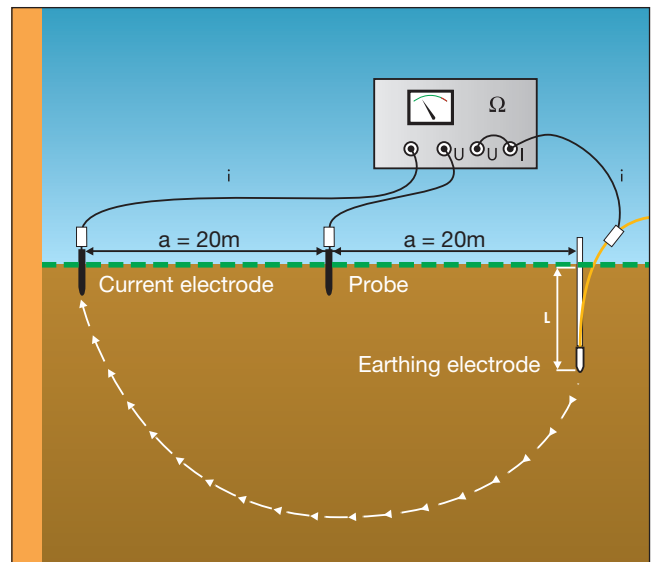

Copper cable as earthing electrode

The special 50 mm² copper cable (individual wire Ø 3 mm) perfectly meets any imaginable requirement for earthing electrodes. Copper is corrosion-resistant and has optimum electrotechnical properties. In addition, the flexible cable provides the required strength to withstand the high mechanic loads without being damaged.



Deep earthing | Procedure

Copper earthing electrode

The earthing electrode

Special 50 mm² bare copper cable with individual wire Ø 3 mm.



	AF-Type	AF-Item number	E number
1	LR3	265.017.552	156 990 620

The advancing rods

Advancing tip made of tempered steel, guide tube and extension tube made of steel.

Two strength classes

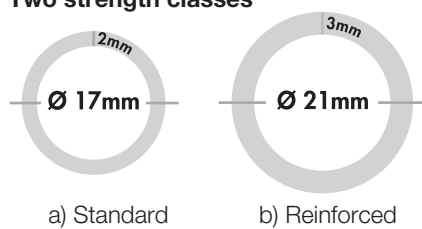

	AF-Type	AF-Item number	E number
2	T3 a)	261.004.021	156 980 010
	T3 b)	261.012.069	156 980 030
3	TE2 a)	261.003.513	156 980 000
	TE2 b)	261.035.000	156 980 020
4	T1 a)	261.002.020	156 980 100
	T1 b)	261.034.000	156 980 110

The shaft / adapter set

Chisel hammer (all conventional types).
For detailed information, please visit our website.

	AF-Type	AF-Item number	E number
5	T9 a) SDS-max	261.040.000	156 981 000
	T9 b) SDS-max	261.043.000	156 981 010

Adapter

Suitable addition to all shaft /adapter sets.

	AF-Type	AF-Item number	E number
6	TE64 a)	261.038.000	156 989 000
	TE64 b)	261.039.000	156 989 010

The impact head

For manual advancing.

	AF-Type	AF-Item number	E number
7	TE63 a)	261.036.000	156 988 000
	TE63 b)	261.037.000	156 988 010

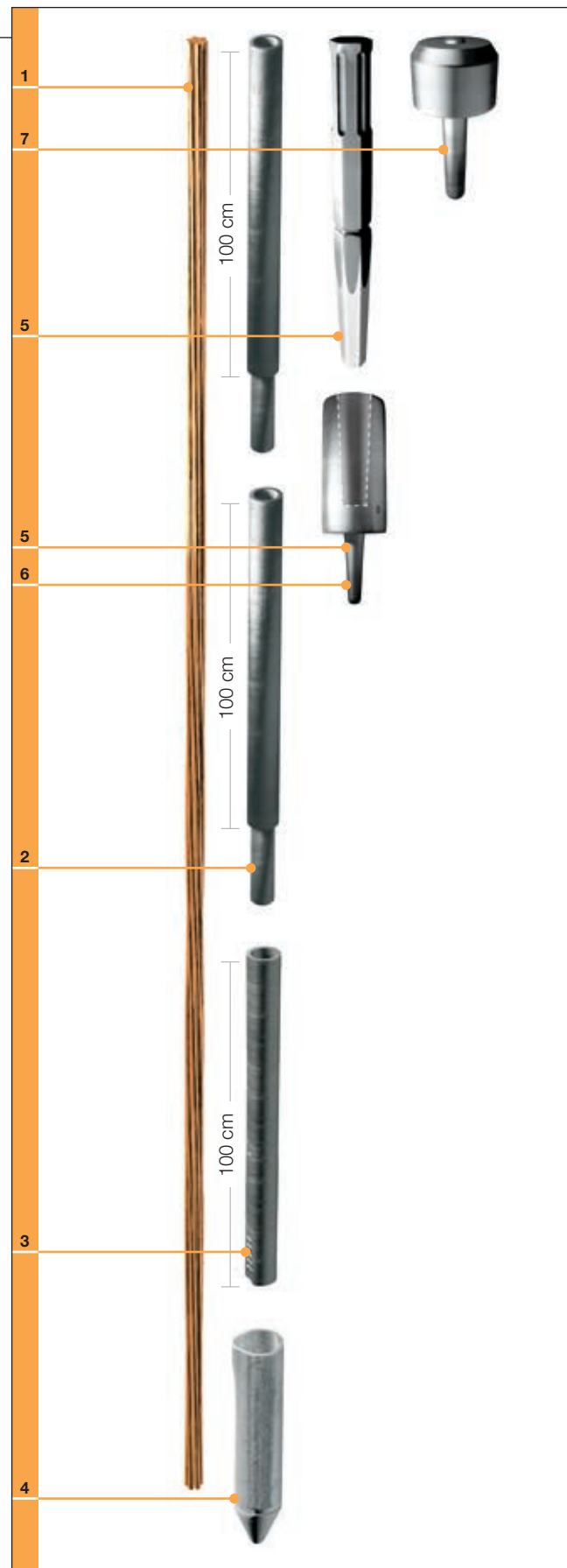

Basic information

Essential factors influencing the earth resistance

The nature of the soil (i.e. the spec. resistance of the soil), the soil moisture and the soil temperature are the decisive factors for the achievable earth resistance.

From a depth of 70 cm, the temperatures and moisture values are relatively constant. A low specific resistance of the soil (e.g. humus or clay) is therefore decisive.

Specific resistance

Humus	approx. 50 Ωm
Clay	approx. 50 Ωm
Sand	approx. 100 Ωm
Gravel	approx. 160 Ωm
Moraine	approx. 1000 Ωm

Corrosion due to the soil and the combination with other earthing systems

The moist soil is the perfect active electrolyte. This means it leads to extreme corrosion of metallic systems installed underground. Copper as precious metal, however, is corrosion-resistant. Bare galvanized and copper-plated iron parts corrode and decay. This is why the standards require that for earth electrodes installed underground only bare copper may be used. In addition, a copper earth electrode is neutral compared to foundation earthing from an electrochemical point of view (iron in the concrete). This means that even in this common combination of earthing systems, no harmful corrosion can occur.

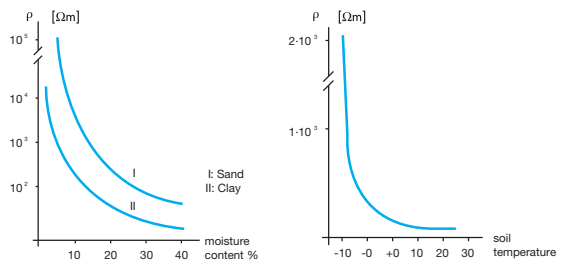

Specific resistance as a factor of the moisture content

Specific resistance as a factor of the temperature

Influence of step voltage on deep earth electrodes

The deeper the electrode is installed in the ground, the smaller the step voltage at the surface. Deep earth electrodes therefore have optimum characteristics.

Maximum step voltage as a factor of the installation depth for an extended earthing strip (measured in cross direction to the earth electrode).

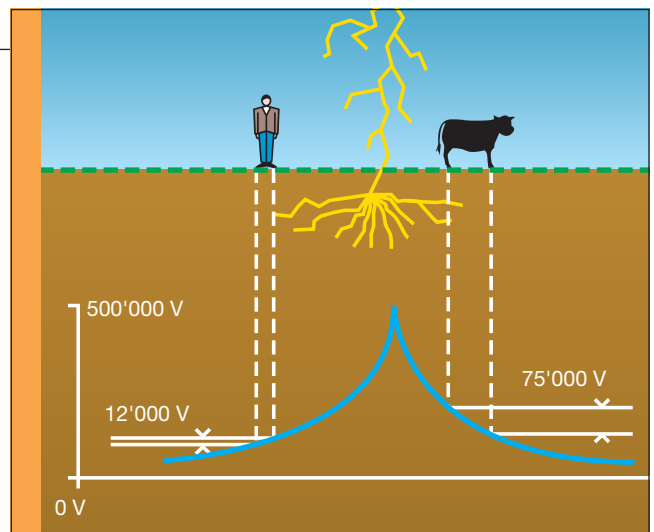

max step voltage in % of the earthing tension

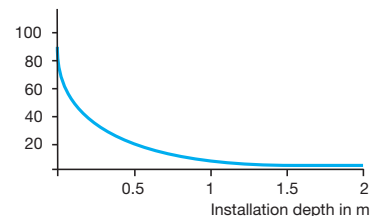

The whole program ONLINE

On www.aflury.ch you can find all information concerning our products and services. You always have access to our newest status of our product data, technical information, installation instructions and pictures.

On our website, you will find any information about activities, trainings and exhibitions.

Have a look at our website www.aflury.ch.

